



nuna

Bugaboo child restraint in
collaboration with Nuna

Bugaboo Turtle by Nuna

INSTRUCTIONS FOR USE



BUGABOO SEAT AND BASE ITEM NUMBER 84701ZW01
/ BASE ONLY 84702ZW01
NUNA SEAT AND BASE MODEL NUMBER CF05703
/ BASE ONLY IF05701

**IMPORTANT: KEEP THIS INSTRUCTION BOOKLET IN THE
PLACE PROVIDED ON THE CHILD RESTRAINT**

bugaboo

nothing like a Bugaboo

when used with additional Bugaboo adapters for designated bugaboo strollers, compatible with:



bugaboo fox



bugaboo bee



bugaboo cameleon



bugaboo donkey



bugaboo lynx

Bugaboo turtle by Nuna is based on the Nuna KLIK plus model

IMPORTANT:
Before installation and use of this child restraint check that it is suitable for the size of your child.

See pages 4 & 7 for more information.

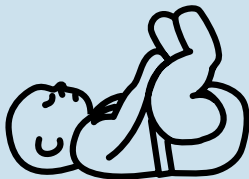

IMPORTANT: This is a rear facing child restraint. Do not face forward.



Distributor: Bugaboo Australia Pty Limited,
suite 2, level 2, 156 Edgecliff Road, Woollahra, NSW 2025

For after sales service: Bugaboo.com/support
service.au@bugaboo.com 02 9091 0322



Contents

Quick Reference	2
WARNINGS	3
Additional Warnings	4
Features	6
Child Size	7
Shoulder Strap Height	8
Crotch Strap Position	9
Securing Child in the Restraint	10
Accessories	13
Canopy	14
Seat Cover Removal	15
Extra Padding	16
Infant Insert	17
Carry Handle	18
The Next Restraint	19
Use with Strollers	20
Cleaning and Maintenance	21

DO NOT USE THIS CHILD RESTRAINT UNTIL YOU HAVE READ AND UNDERSTOOD THE INSTRUCTIONS IN THIS USER GUIDE AND IN YOUR VEHICLE OWNERS MANUAL

Quick Reference

IMPORTANT: After reading this Quick Reference read the following instructions carefully.

Shoulder Straps

must always be at correct height and pulled tight. See pages 7 & 8

Head Liners and Infant Insert

only use for smaller children who require more support. See page 17

Shoulder Height

shoulders must not be above the marker line See page 8

Harness Straps

must not be twisted. See page 12

Harness Buckle

must always be securely fastened. See page 11

Harness Tension

pull harness tight. See page 11

Suitable Clothing

child's clothing must not interfere with the harness See page 13

Child Position

child must be in full contact with back of restraint. See page 10

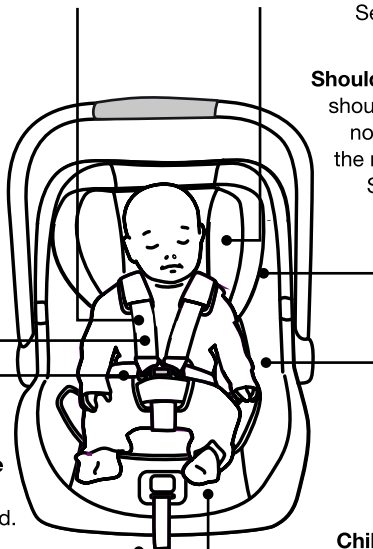

WARNING

- Use the restraint exactly as shown in the instructions.
- Supervision of children is needed because they may be able to undo buckles.
- To ensure that baby's back is evenly supported, do not put more than one nappy on the baby and make sure the nappy is not folded thickly at the back.
- Fit the harness firmly to the child.
- A loose harness or restraint is dangerous.
- Do not harness an infant wrapped in a blanket or swaddled. Any blanket or wrap must only be placed over the harness and infant.
- Do not allow the restraint to come into contact with polishes, oils, bleach and other chemicals.
- Only use this restraint with the base it was supplied with. If a second or replacement base is required it must be a matching model number.
- DO NOT USE THIS RESTRAINT WITHOUT THE COVER.
- DO NOT USE A REAR FACING CHILD RESTRAINT WHERE AN AIRBAG IS FITTED IN FRONT OF THE SEATING POSITION.

WARNING

DO NOT LEAVE CHILDREN UNATTENDED IN THE CAR

NOTE: The warnings on these pages are those required by the Australian and New Zealand Standard AS/NZS 1754 for this type of child restraint. Other warnings specific to this particular child restraint will be found throughout these instructions.

This Child Restraint is suitable for children up to approximately 12 months of age. See page 7 for more detailed information.

⚠️ ADDITIONAL WARNINGS

This Child Restraint is:

To be used only in a rearward-facing position until the infant's shoulders reach the shoulder height marker (approximately 12 months of age).

Continue to use this infant restraint until the child reaches this limit.

Infants are at risk of serious injury if they face forward too early.

Ensure that children have adequate ventilation and shade when in the vehicle.

Aftermarket accessories (i.e. items not provided in the box with the child restraint), may not have been tested for use with this child restraint and if used, may lower the level of protection offered possibly leading to injury or death.

Any aftermarket accessory used should be compliant with AS/NZS 8005 (Accessories for child restraints for use in motor vehicles) and stated as suitable for use with this child restraint.

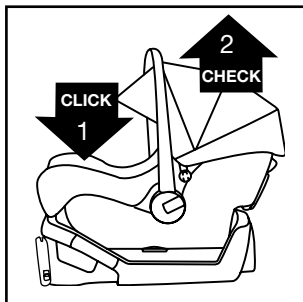

Always check child restraint to base connection.

⚠️ ADDITIONAL WARNINGS

When baby is in the restraint, ALWAYS secure the harness and adjust to a firm fit.

Always check buckle and other parts for hot surfaces. A child restraint left uncovered in the sun could burn a child. Cover with blanket if leaving in car.

Fall hazard: Child's movement can slide carrier. NEVER place child restraint near edges of countertops, tables or other high surfaces. Always stay within arms reach whenever child restraint is not on floor/ground.

Suffocation hazard: child restraint can roll over on soft surfaces and suffocate child. Never place child restraint on beds, sofas, or other soft surfaces.

Strangulation hazard: Child can strangle in loose child restraint straps. Always use harness. Never leave child in the child restraint when straps are loose or undone.

Never place the child restraint on top of a shopping cart. The child restraint will not be properly secured and could fall.

Do not use the child restraint if it is damaged or broken.

Only use with Bugaboo strollers or appropriate Bugaboo adapters designed for use with other strollers.

Features

- 1 Carry Handle
- 2 Headrest
- 3 Infant Insert
- 4 Shoulder Pads
- 5 Buckle and Crotch Pad
- 6 Harness Adjuster Button
- 7 Harness Adjuster Strap
- 8 Canopy
- 9 Carry Handle Lock
- 10 Harness Straps
- 11 Seat Cover
- 12 Stroller Release Handle
- 13 Base Attachment Bars

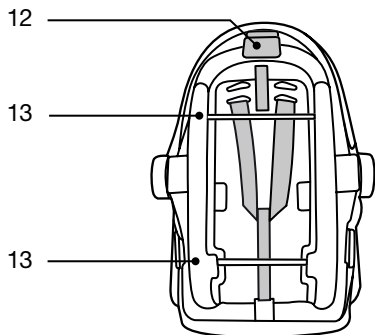
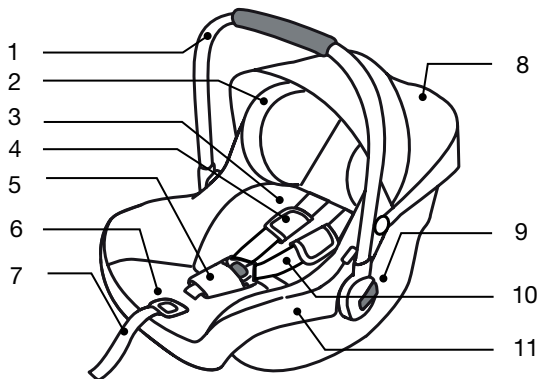

Child Size

This restraint has a shoulder height level label. Use this to know when your child is too big for the restraint.

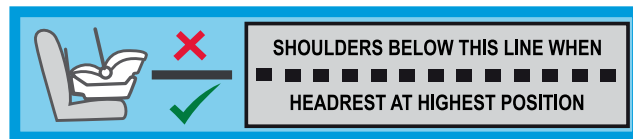

Once your child's shoulders reach the dotted line, it is time to move to a bigger restraint. See page 19.

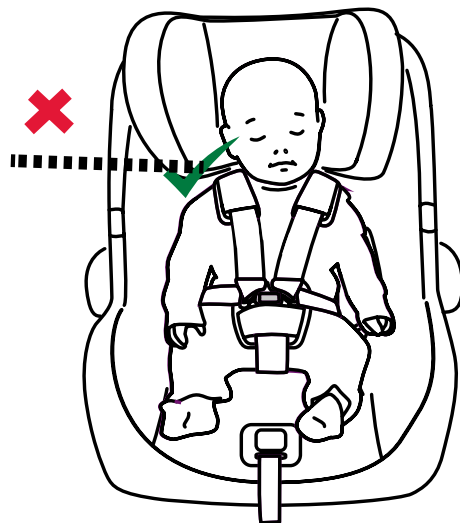

USE

USE

Shoulder Strap Height

Correct positioning of the shoulder straps is essential for your baby's safety.

Requirement:

The shoulder strap slots must be in the first adjustment position above the child's shoulders, and not lower than the child's shoulders.

TO CHECK:

- 1 With child placed in the restraint, note where the shoulder straps are relative to the child's shoulders.
- 2 Refer to the requirements above.



TO ADJUST:

- 3 The shoulder straps move with the headrest. Adjust the headrest height by squeezing the release lever at the back of the headrest and raising or lowering it as required.

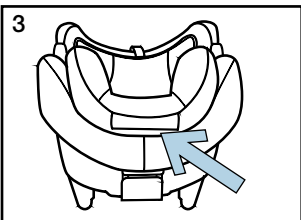
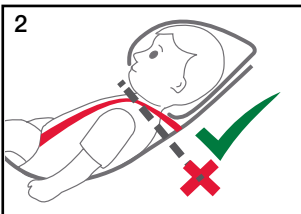

IMPORTANT: Always adjust the height of the shoulder straps as the child grows

Crotch Strap Position

There are two positions available for the crotch strap.

The rear position is recommended for normal use and the front position with a bigger child. The steel buckle must be fully through the slot.

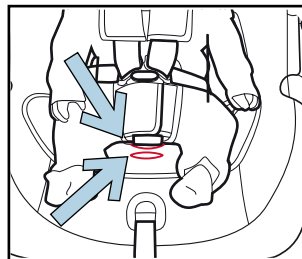

View from underneath the shell—check the buckle is fully through the slot.

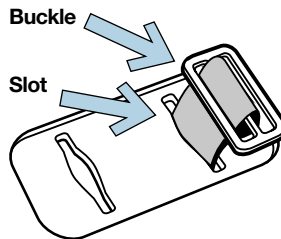

IMPORTANT: After changing the strap position pull firmly upward on the crotch strap to check the buckle is securely fitted.

Securing Child in the Restraint

First check shoulder strap height and adjust if necessary.

See pages 7 & 8

- 1 Loosen harness by pressing on adjuster button while pulling on the harness straps.

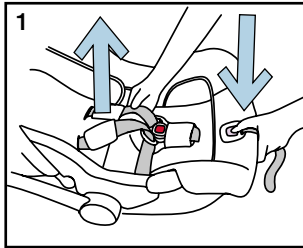

- 2 Press button to open the quick release buckle. Spread harness straps apart.

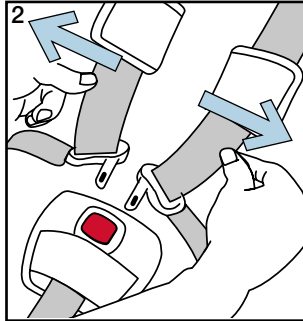

- 3 Place child in restraint in seated position.

Child's back must be firmly against both the back and bottom of the restraint.



- 4 Place buckle tongues into the quick release buckle.

IMPORTANT: Both buckle tongues should "CLICK" into place. If they do not click, try again or try cleaning the buckle. See page 21.

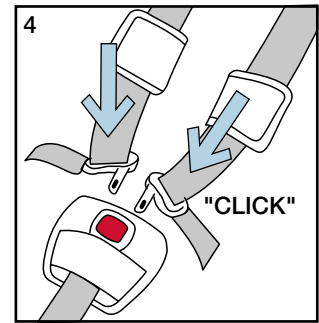

- 5 Tighten harness by pulling on the adjuster strap at the front of the restraint.

Note: you may need to pull excess shoulder strap webbing through the Quick Release Buckle. Tongues upward towards the child's shoulder and then pull on the adjuster strap.

This may need to be repeated several times to get the webbing fitting snugly.

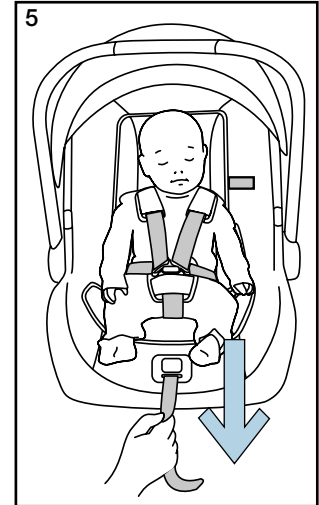

⚠ WARNING

DO NOT LEAVE CHILDREN UNATTENDED IN THE CAR

CHECK

- **Strap tension:**
Put finger under strap and pull out.

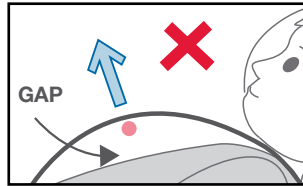
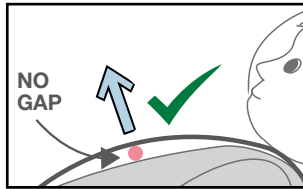

- Harness is snug around the child's waist and shoulders.

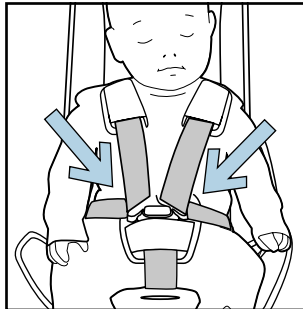

- Shoulder Straps must not be twisted.

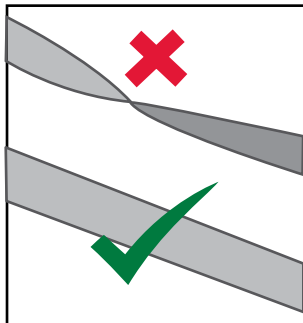

IMPORTANT

Child must be dressed in clothing that allows the harness to firmly secure them.

Blankets

Never use blankets or clothing that interfere with the harness as a poorly secured child can come out of the restraint during a crash. Only place blankets over child AFTER harness has been properly tightened.

Swaddling

Infants need to be securely held by the harness. An infant wrapped in a blanket or swaddled will not be securely held and may be ejected and killed in an accident

Do not bind or wrap the infants arms or legs together.

Accessories

DO NOT add accessories, toys, padding or other items to the child restraint unless provided by Bugaboo.

Aftermarket accessories (i.e. items not provided in the box with the child restraint), may not have been tested for use with this child restraint and if used, may lower the level of protection offered possibly leading to injury or death.

Any aftermarket accessory used should be compliant with AS/NZS 8005 (Accessories for child restraints for use in motor vehicles) and stated as suitable for use with this child restraint.

Canopy

To remove the canopy, release the press studs, and press the buttons in the canopy mounts. Then pull the canopy bow out.

To replace simply plug the canopy bows in until they click and refasten the press studs.

The Canopy has a Smart Visor that can be folded out for more protection. There is a sunscreen attached to the front of the visor.

This sunscreen can be fixed to magnetic anchor points at the front corners of the restraint.

IMPORTANT: Do not use the visor and sunscreen in a vehicle as it will interfere with the tether strap.

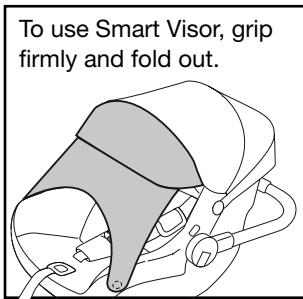
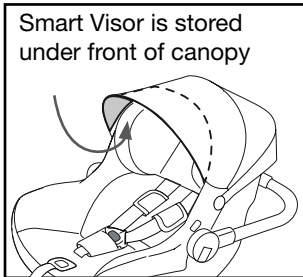
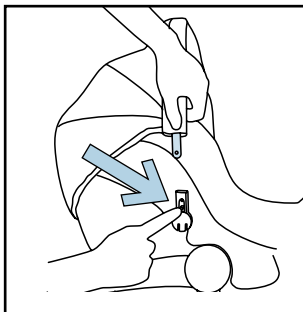

Seat Cover Removal

- 1 Pull the fastening pieces underneath the edge of the seat out.

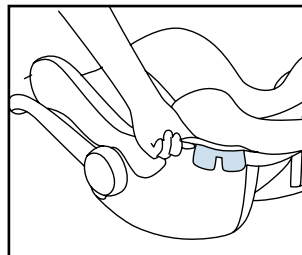

- 2 Remove the seat cover from the adjustment button as shown.

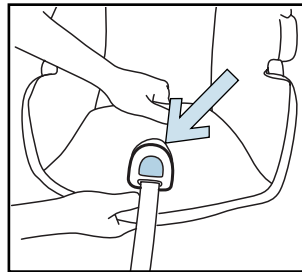

- 4 Remove the seat pad from the stroller release button as shown.

Lift cover off seat starting from the back.

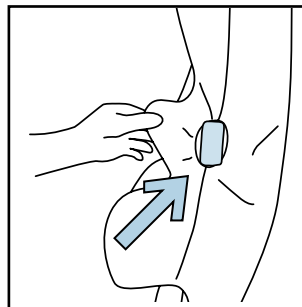

VERY IMPORTANT: Only replace the cover with a Bugaboo supplied replacement cover with identical shoulder height markers or a replacement cover meeting AS/NZS 8005.

Extra Padding

Shoulder pads and the crotch strap pad are not necessary for safety and are removable.

Crotch Pad Removal

The crotch pad is secured by a small strap that passes through the slot at the bottom of the buckle.

- 1 - Unbuckle the harness and locate the crotch pad strap.
- 2 - Keep the tab at the end of the crotch pad strap flat against the strap and pull it through the slot in the buckle.
- 3 - Pull the crotch pad off the buckle.

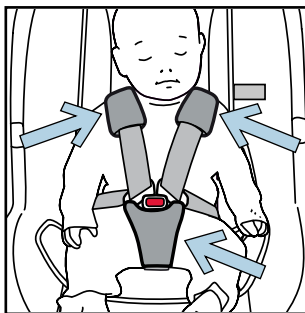

Infant Insert

The infant insert can be used to provide a snug fit for smaller babies.

Only use the infant insert for smaller babies.

When the child is bigger and the headrest is moved up remove the Insert.

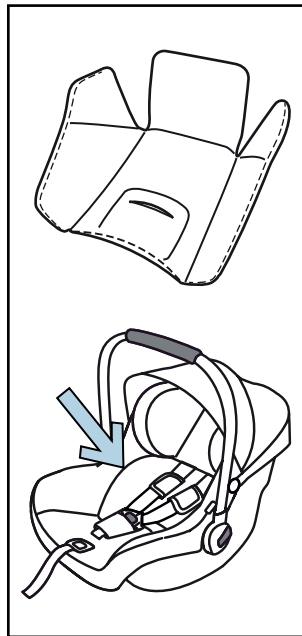

USE

Carry Handle

The carry handle can be adjusted to 3 positions.

- 1 To adjust the handle position, squeeze handle buttons on both sides and rotate.
- 2 Rotate handle until it clicks into any of the 3 positions.

The carry handle can be used in a vehicle in any locked position.

Be sure handle is locked in the carry position before lifting carrier by handle. An unlocked handle could move unexpectedly, causing injury to child.

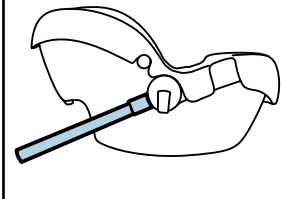
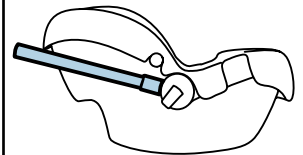
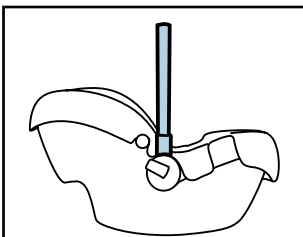
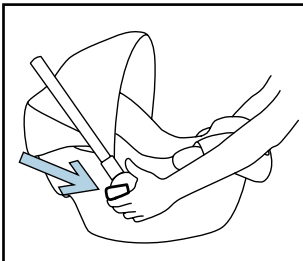

The Next Restraint

This restraint is suitable for a baby up to approximately 12 months of age.

When the baby's shoulders are level with the shoulder height marker (see page 7) they should move to a bigger restraint.

The next category of restraint is forward facing and has a six point harness and will be suitable for the child until they are approximately 4 years of age.

IMPORTANT: if the baby's neck muscles are unable to support their head, they should remain rear facing.

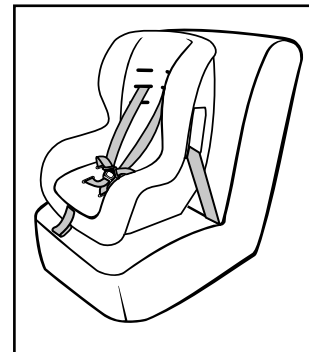

Use with Strollers

This child restraint can attach to Bugaboo strollers using adapters. Instructions are included with the adapters, which are sold separately.

Cleaning and Maintenance

Seat Cover

Use mild soap or upholstery shampoo.

Wash separately.

Do not bleach.

Do not soak.

Do not tumble dry.

Dry flat in the shade thoroughly before reuse and avoid direct heat and sunlight.

Do not dry clean.

Plastic and Metal Parts

Use only mild detergent, water and a soft cloth to clean the car seat shell, handle and harness straps. Air dry.

Do not use undiluted detergent, or other solvents to clean - these may cause damage.

Harness Buckle

To clean the buckle: rinse using warm water. DO NOT use any soaps, solvents or lubricants. Using anything other than water can cause the buckle to malfunction. Air dry.

When the buckle is operating correctly the tongues will push in easily and will CLICK when they latch into place.

If the buckle does not appear to be working correctly get it checked or replaced by contacting the retailer from where it was purchased.

Harness Straps

Spot clean. If damaged contact the retailer from where the restraint was purchased to have them replaced.

Storage

Remove the child restraint from the vehicle seat if not in use for a long period of time. Put the child restraint in a cool, dry place and somewhere your child cannot access it.

The information contained herein is subject to change without notice. Bugaboo International BV shall not be liable for technical errors or omissions contained herein. The purchased product may differ from the product as described in this user guide. Our most recent user guides can be requested at our service departments or at www.bugaboo.com. © 2019 Bugaboo International BV. BUGABOO, BUGABOO FOX, BUGABOO CAMELEON, BUGABOO BEE, BUGABOO DONKEY, BUGABOO BUFFALO, RUNNER, BUGABOO BOXER and the Bugaboo logos are registered trademarks. The Bugaboo® strollers are patented and design protected. ©2019 Nuna International B.V. Nuna and all associated logos are trademarks.